

P/N: FAPE200602

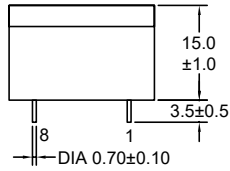

Outline Dimensions(Unit:mm)



Front View

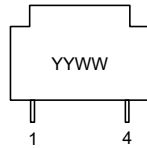

Side View

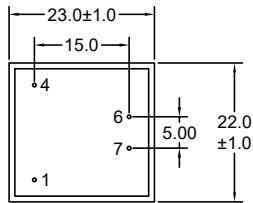

Bottom View

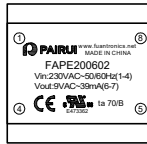

Top View

Note:

1.Remove Pins 2,3,5,8.

Electronical Schematic

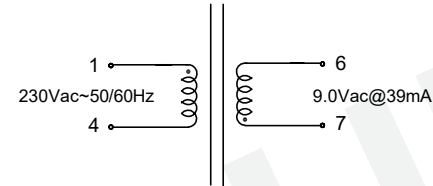

Electrical Characteristics

Input 230Vac 50Hz to 1-4 :
 Excitation current(Ix):15mA Max.
 Output: Vo=16.5Vac Typ(No-load).
 VL=9.0Vac±5%(@39mA).
 D.C.Resistance:1-4=12300 ohms±15%.
 6-7=115.0 ohms±15%.
 Hi-Pot: Pri-Sec:4000VAC/5mA/60Second.
 Insulation Resistance: Pri-Sec:100 Mohms Min @500VDC.

Wave Soldering

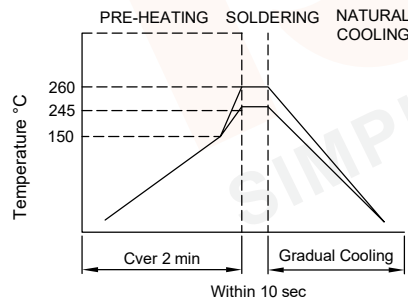

Note:
 1.Never Contact the ceramic with the iron tip;
 2.1.0mm tip diameter(max).

General Properties

Operating Temperature:-25°C to +70°C.
 Storage Temperature:-25°C to +85°C.
 Insulation Class: B.

| | | | | | | | | |
|-----|-------------|------|------|---|--|---|--|--|
| | | | | Tianchang Fuan Electronic Co Ltd www.fuantronics.net TEL: +86-550-7814888 FAX: +86-550-7831133 | Tolerances unless otherwise specified: (.X)±0.50 (XX)±0.25 Unit of measurement: mm | Make: Qiumei.Liu Checked: Beson. zhan Approved: Anson. zhan | DRAWING TITLE 0.35W Encapsulated Transformer For EE20*6.1,230VAC Input 50/60Hz Material Number: A222006XS010 | Customer Name: Document/Rev: 00 Specification Sheet: 1 of 3 Date of Recognition: Jan./02/2020 |
| REV | DESCRIPTION | APPD | DATE | | | | | |

P/N: FAPE200602

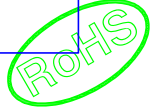

List of UL Certificate:

| No. | Part Name | Mat'l Description | Supplier | UL Number |
|-----|-------------|----------------------------|-------------------------------------|-----------|
| 1 | Bobbin | EE20*6.1/PBT(Black) | Chang Chun Plastics Co Ltd | E59481 |
| 2 | Case | CASE-EE20*6.1/PA66(Orange) | Zhejiang Juner New Materials Co Ltd | E204321 |
| 3 | Copper wire | 2UEW-H/180C | Elektrisola Hangzhou Co Ltd | E258243 |
| 4 | Core | Lamination(Z11) | Ta Yea Steel Industry Co Ltd | N/A |
| 5 | Epoxy | PU552(Black) | Wevo-Chemle Gmbh | E108835 |
| 6 | | | | |

Packaging Specification:

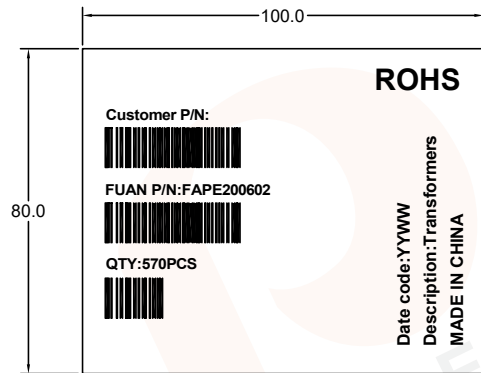

Laber of outer

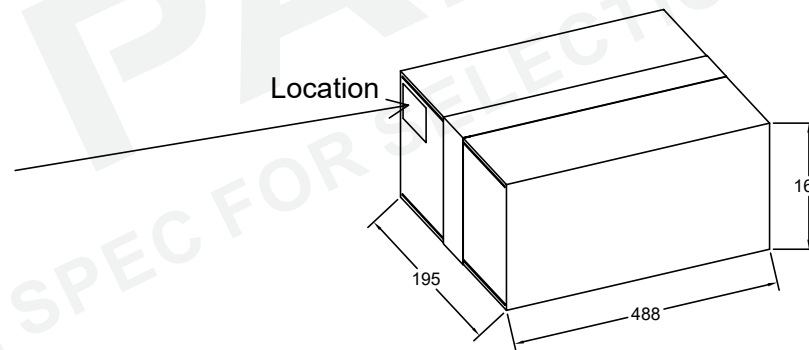

put the label on the top left corner of one of the carton sides

| | | | | | | | | |
|-----|-------------|------|------|---|--|---|--|--|
| | | | | Tianchang Fuan Electronic Co Ltd www.fuantronics.net TEL: +86-550-7814888 FAX: +86-550-7831133 | Tolerances unless otherwise specified: (.X)±0.50 (XX)±0.25 Unit of measurement: mm | Make: Qiumei.Liu Checked: Beson. zhan Approved: Anson. zhan | DRAWING TITLE 0.35W Encapsulated Transformer For EE20*6.1,230VAC Input 50/60Hz Material Number: A222006XS010 | Customer Name: Document/Rev: 00 Specification Sheet: 2 of 3 Date of Recognition: Jan./02/2020 |
| REV | DESCRIPTION | APPD | DATE | | | | | |

P/N: FAPE200602

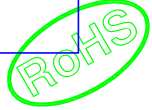

Packing Method:

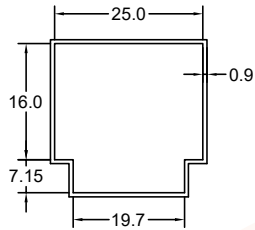
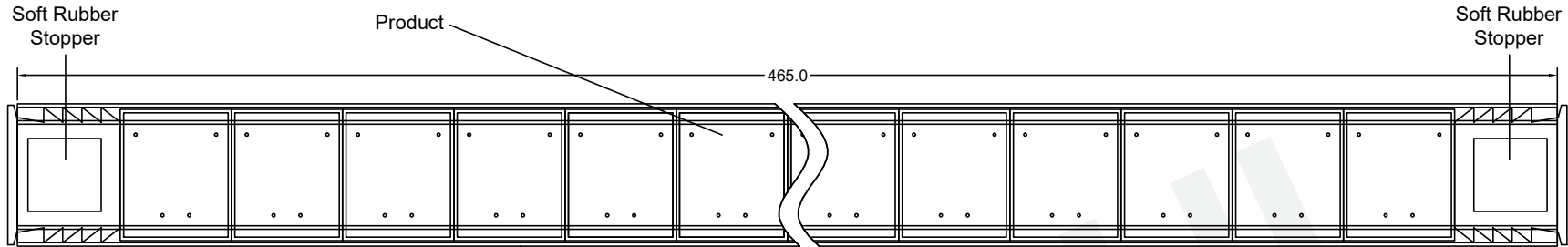

Size of packaging tube:
460mm*26.8mm*25.0mm
(Length * Width * Height)

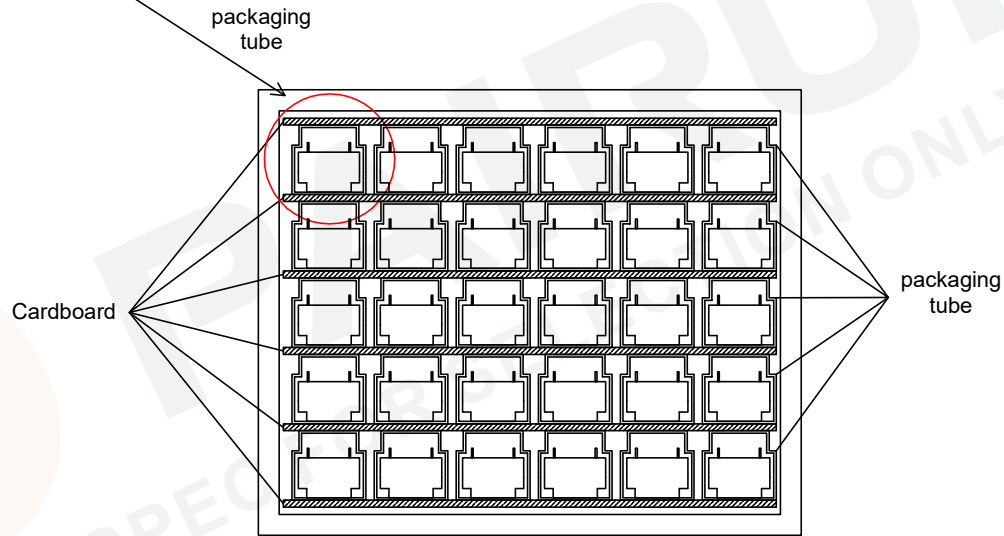

Carton Box Side View

| Layer/Carton | Quantity/Tube (pcs) | Quantity/Carton (pcs) | Net weight (g/pc) | Gross weight (g/tube) | Tubes/carton (pcs) | Total weight (kg) | box size Dimensions (mm) |
|--------------|---------------------|-----------------------|-------------------|-----------------------|--------------------|-------------------|--------------------------|
| 5.0 | 30.0 | 570.0 | 11.8 | 65.00 | 19.00 | 9.19 | 488*195*160 |

| REV | DESCRIPTION | APPD | DATE |
|-----|-------------|------|------|
| | | | |

Tianchang Fuan Electronic Co Ltd
www.fuantronics.net
TEL: +86-550-7814888
FAX: +86-550-7831133

Tolerances unless otherwise specified:
(.X)±0.50 (XX)±0.25
Unit of measurement: mm

Make: Qiumei.Liu
Checked: Beson. zhan
Approved: Anson. zhan

DRAWING TITLE
0.35W Encapsulated Transformer
For EE20*6.1,230VAC Input 50/60Hz
Material Number: A222006XS010

Customer Name:
Document/Rev: 00
Specification Sheet: 3 of 3
Date of Recognition: Jan./02/2020